

DETAILS

Painted steel oil tank for hand pumps lt. 1

SPECIFICATIONS

Model S1 ac 100x150x120
Suction pipe included
Breather cap 1/4 G
Release cap 1/4 G
Standard colour black

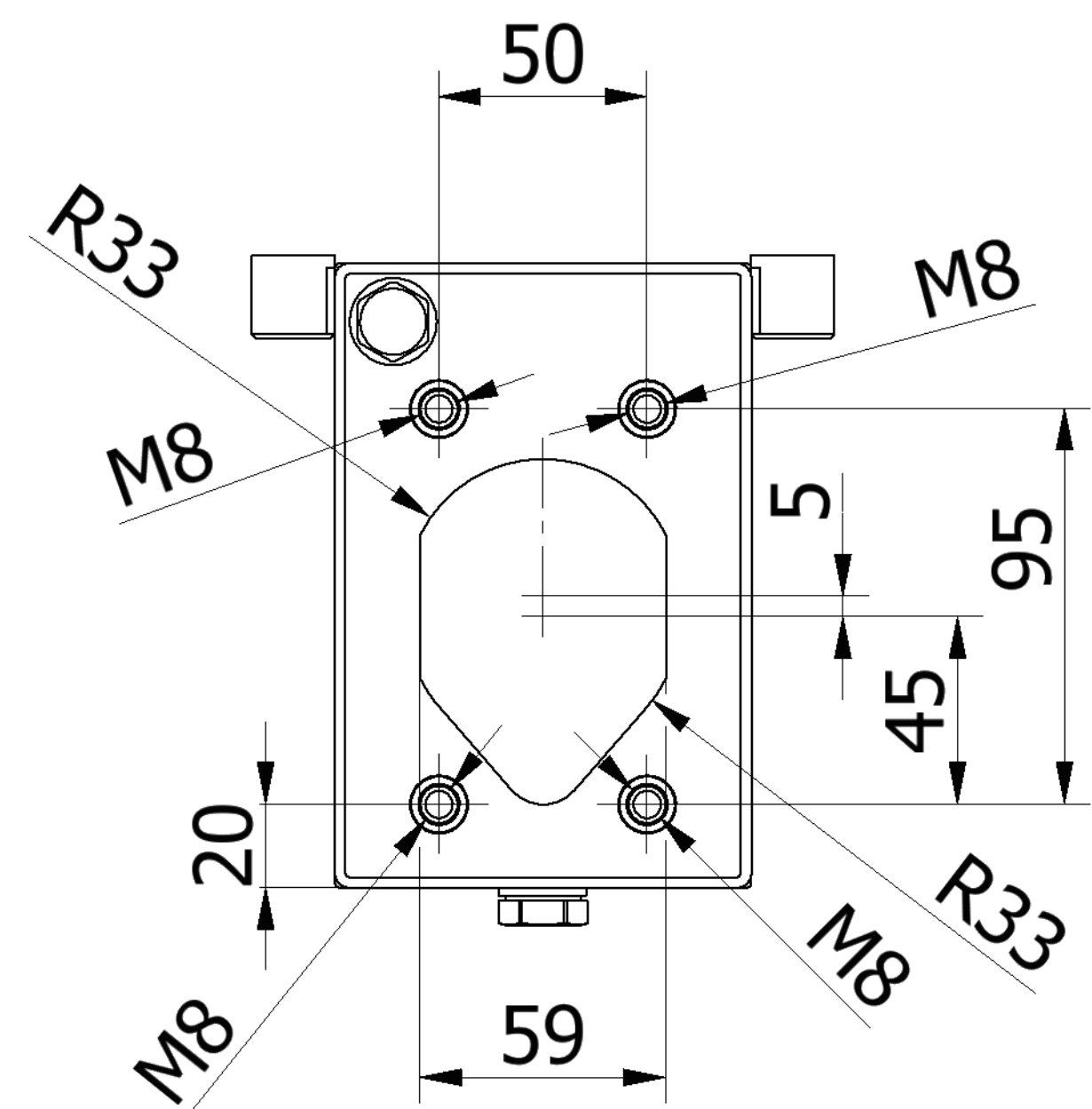
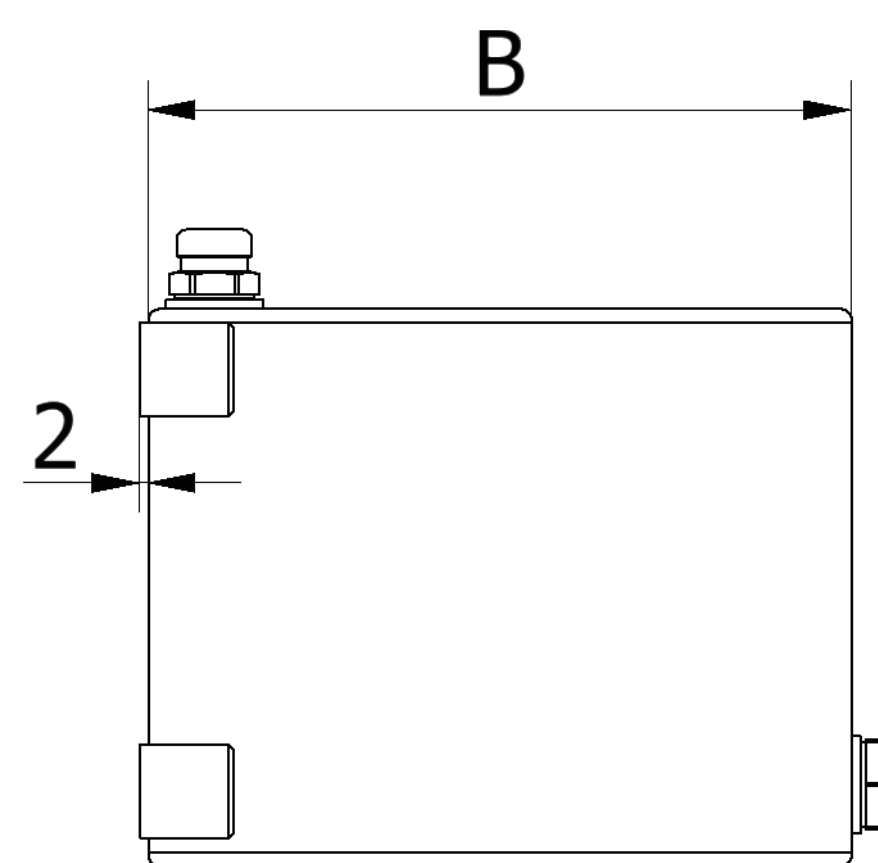
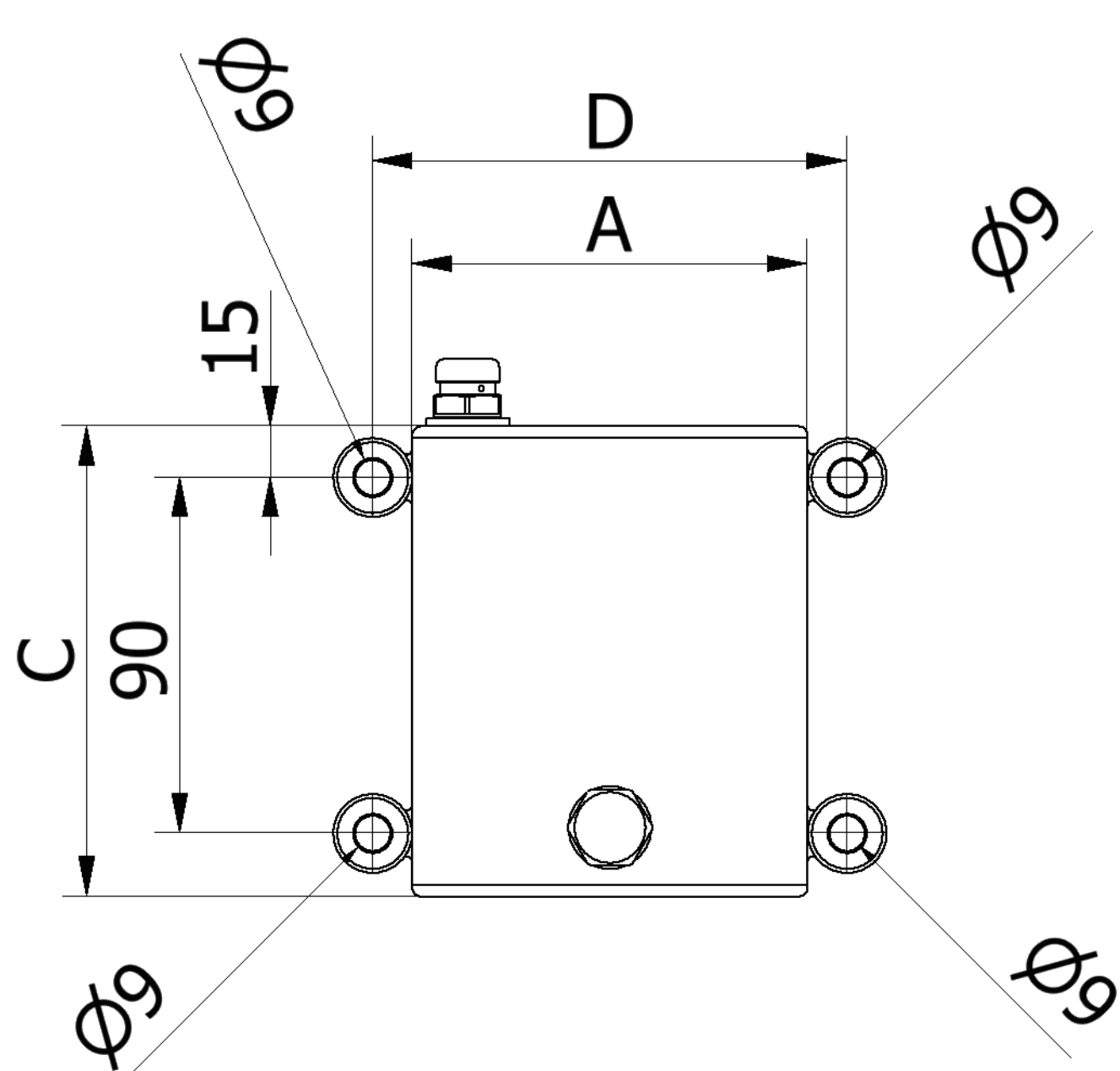
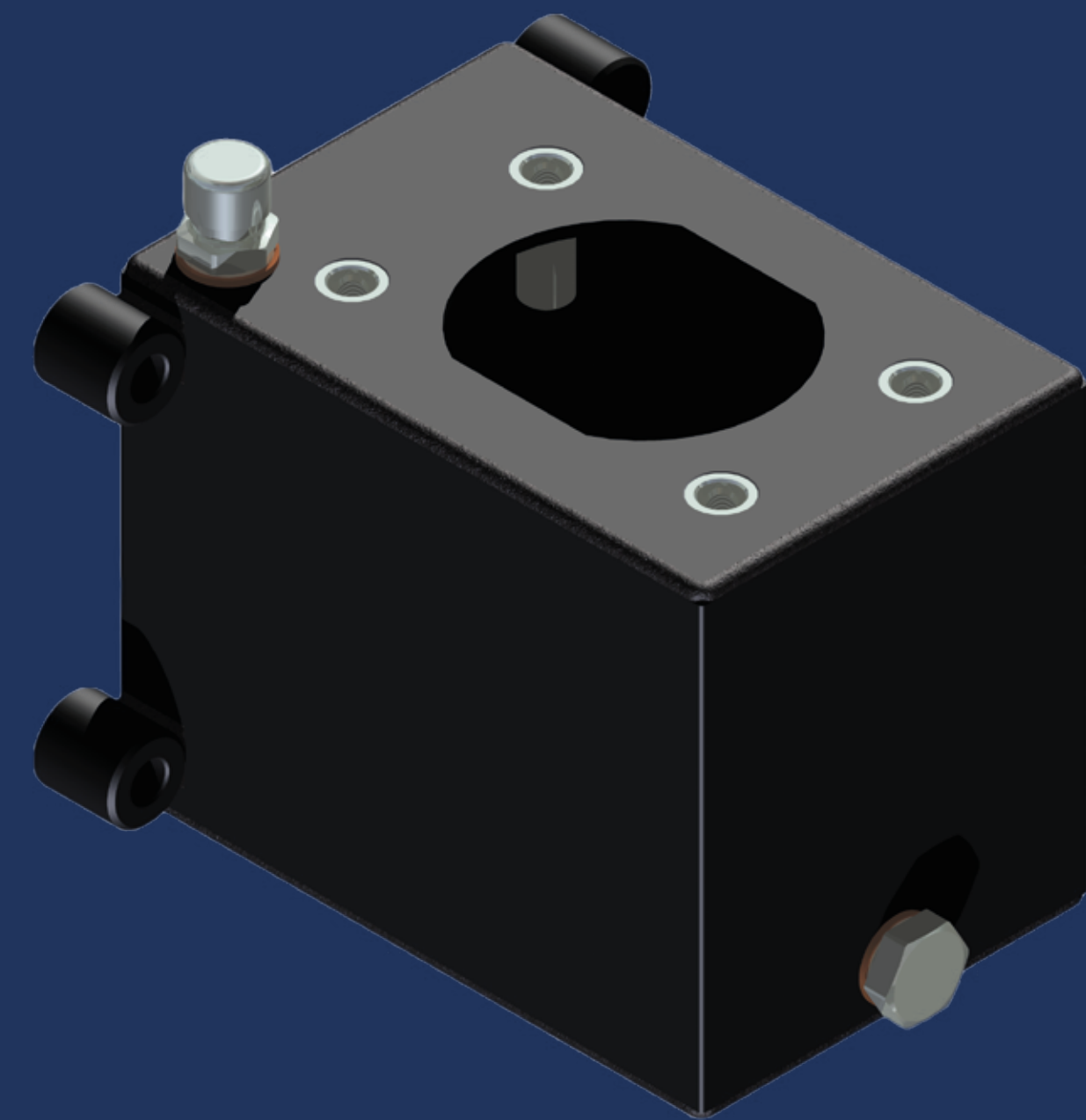

CAPACITY liters	A mm	B mm	C mm	D mm	MASS KG	SUCTION PIPE	CODE
1	100	150	120	120	2,200	Ø10x85 mm	6500.0140