

DETAILS

Painted steel oil tank for hand pumps lt. 10

SPECIFICATIONS

Model S10 ac 175x175x380
Suction pipe included
Breather cap 1/4 G
Release cap 1/4 G
Standard colour black

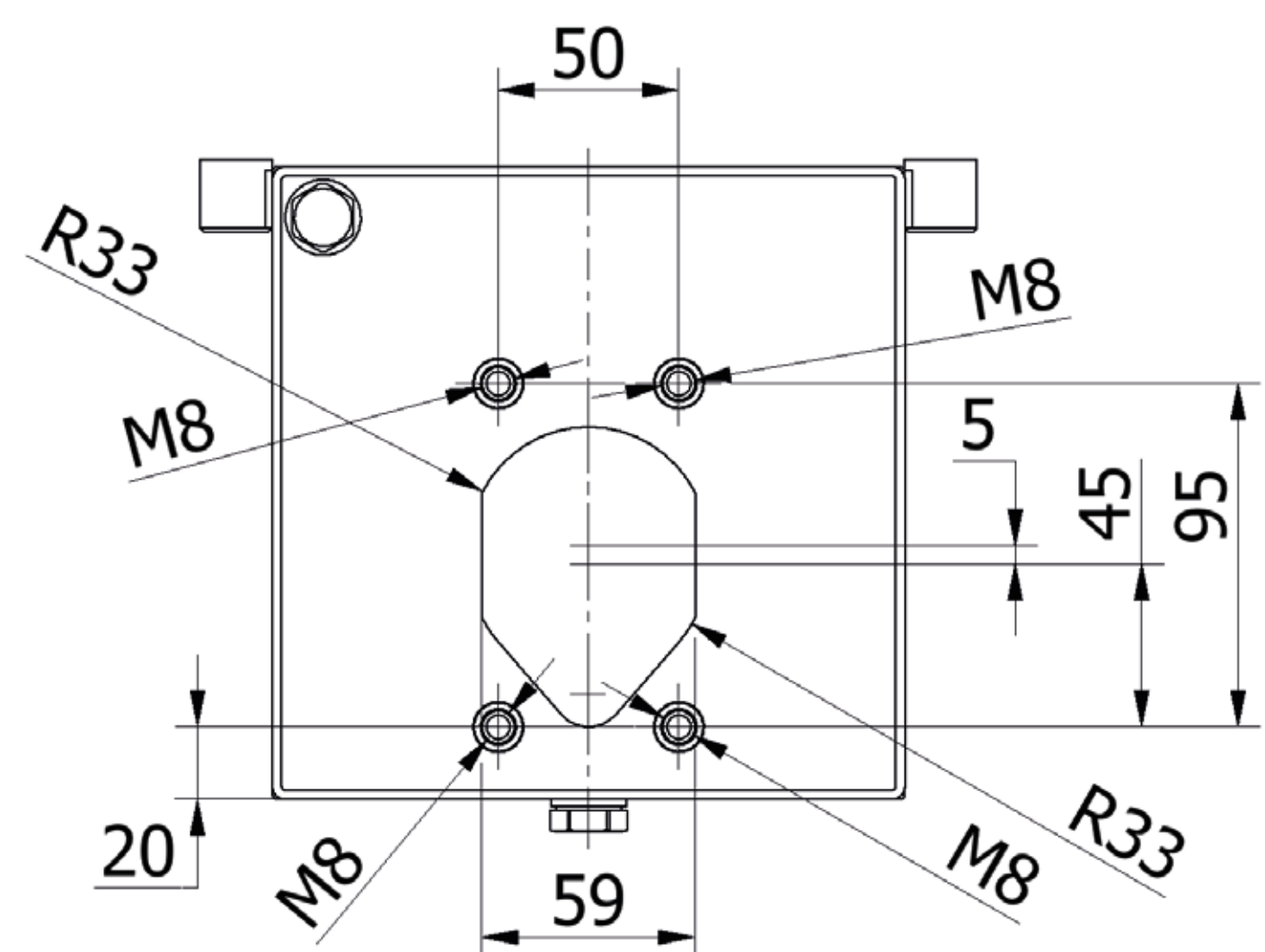
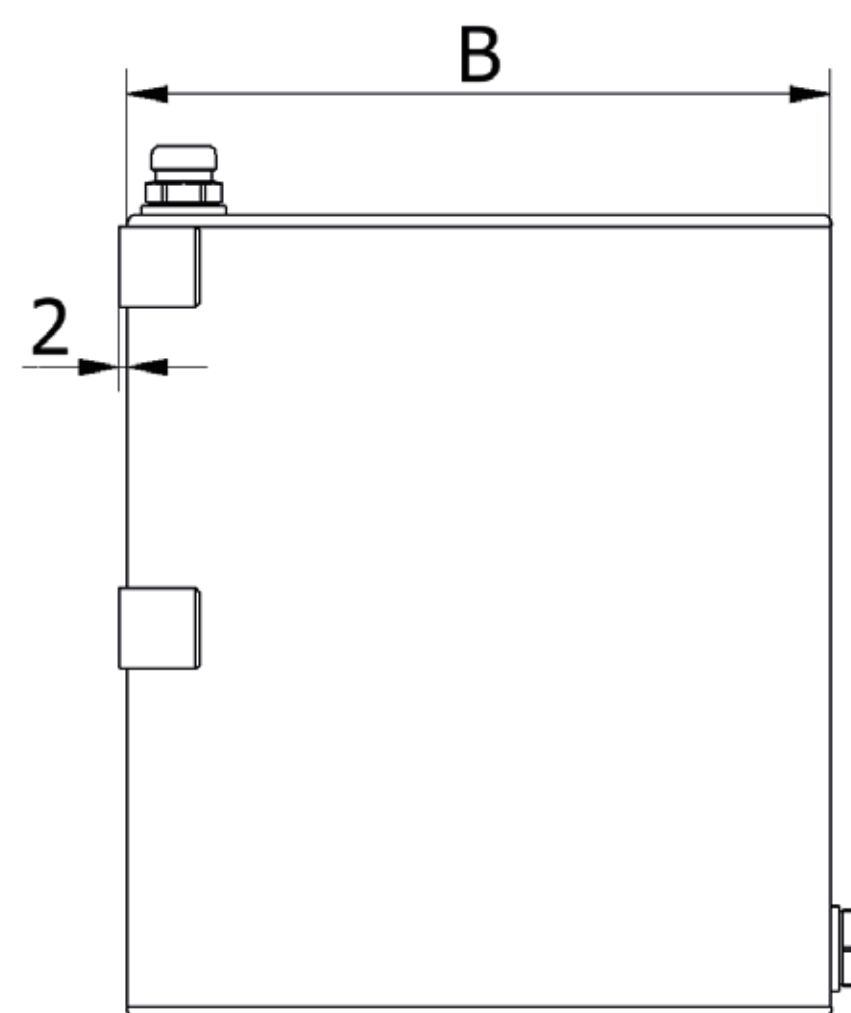
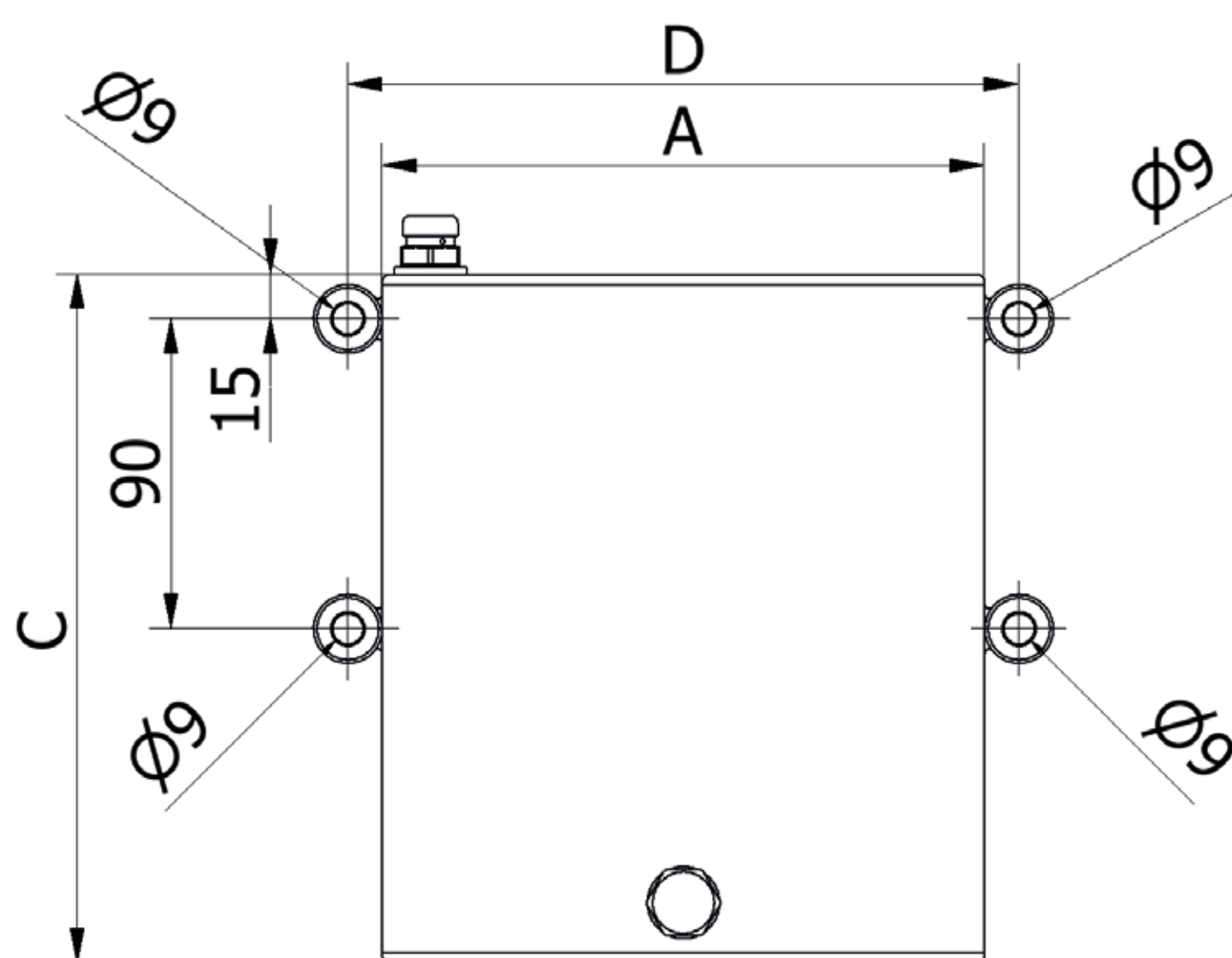

CAPACITY liters	A mm	B mm	C mm	D mm	MASS KG	SUCTION PIPE	CODE
10	175	175	380	195	8,300	Ø10x325 mm	6500.0145