

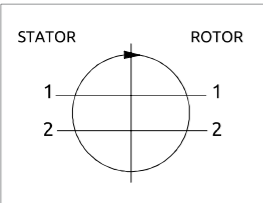

Distributore rotante 02 vie
Swivel joint 02 ways

Item code
D085020400

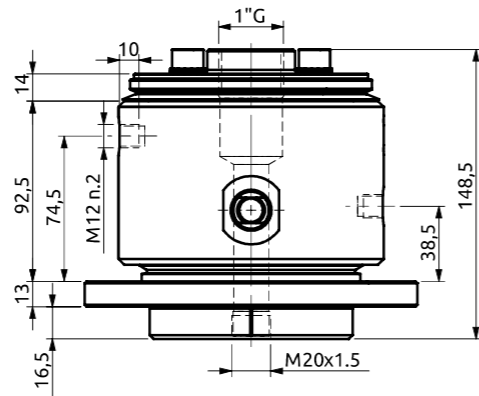
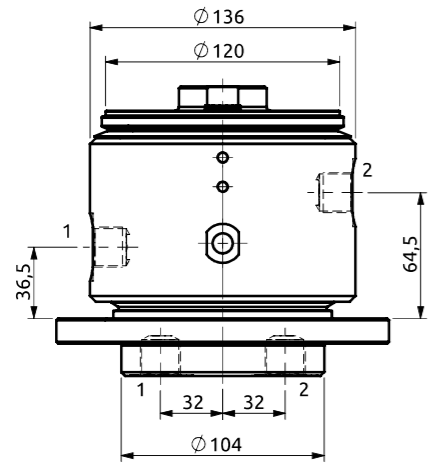
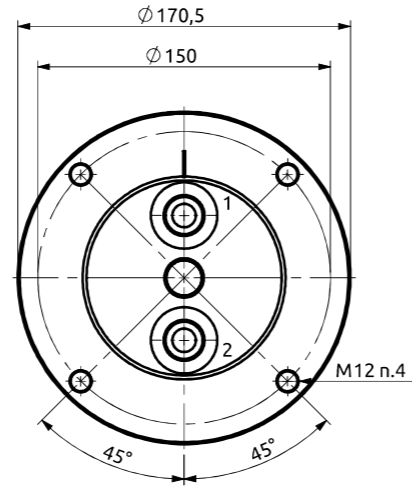

POS.	Statore Stator	Rotore Rotor	DN (mm)	Pressione max a 12RPM (bar) Max pressure at 12RPM (bar)	Fluido Fluid
1	1/2"G	1/2"G	12	300	Hydraulic Oil
2	1/2"G	1/2"G	12	300	Hydraulic Oil



Distributore rotante 02 vie
Swivel joint 02 ways

Item code
D085020500

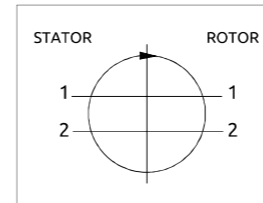
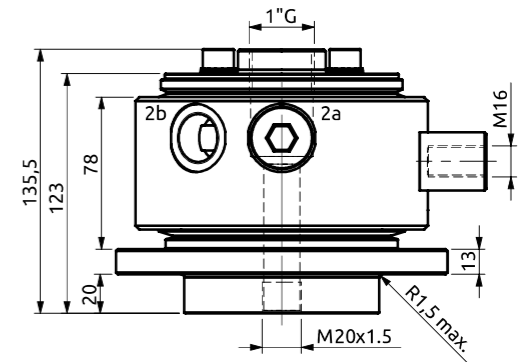
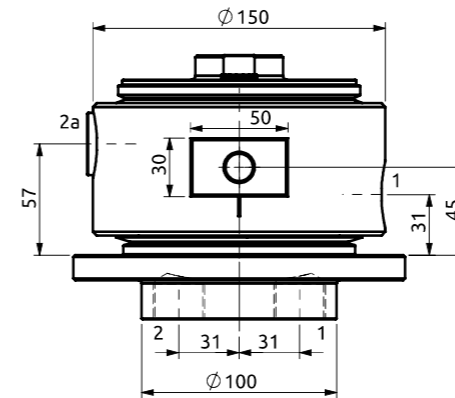
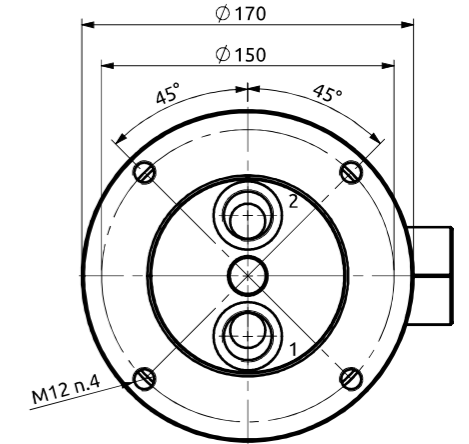

POS.	Statore Stator	Rotore Rotor	DN (mm)	Pressione max a 12RPM (bar) Max pressure at 12RPM (bar)	Fluido Fluid
1	3/4"G	3/4"G	18	420	Hydraulic Oil
2	3/4"G	3/4"G	18	420	Hydraulic Oil