

DETAILS

Painted steel oil tank for hand pumps lt. 3

SPECIFICATIONS

Model S3 ac 100x150x255
Suction pipe included
Breather cap 1/4 G
Release cap 1/4 G
Standard colour black

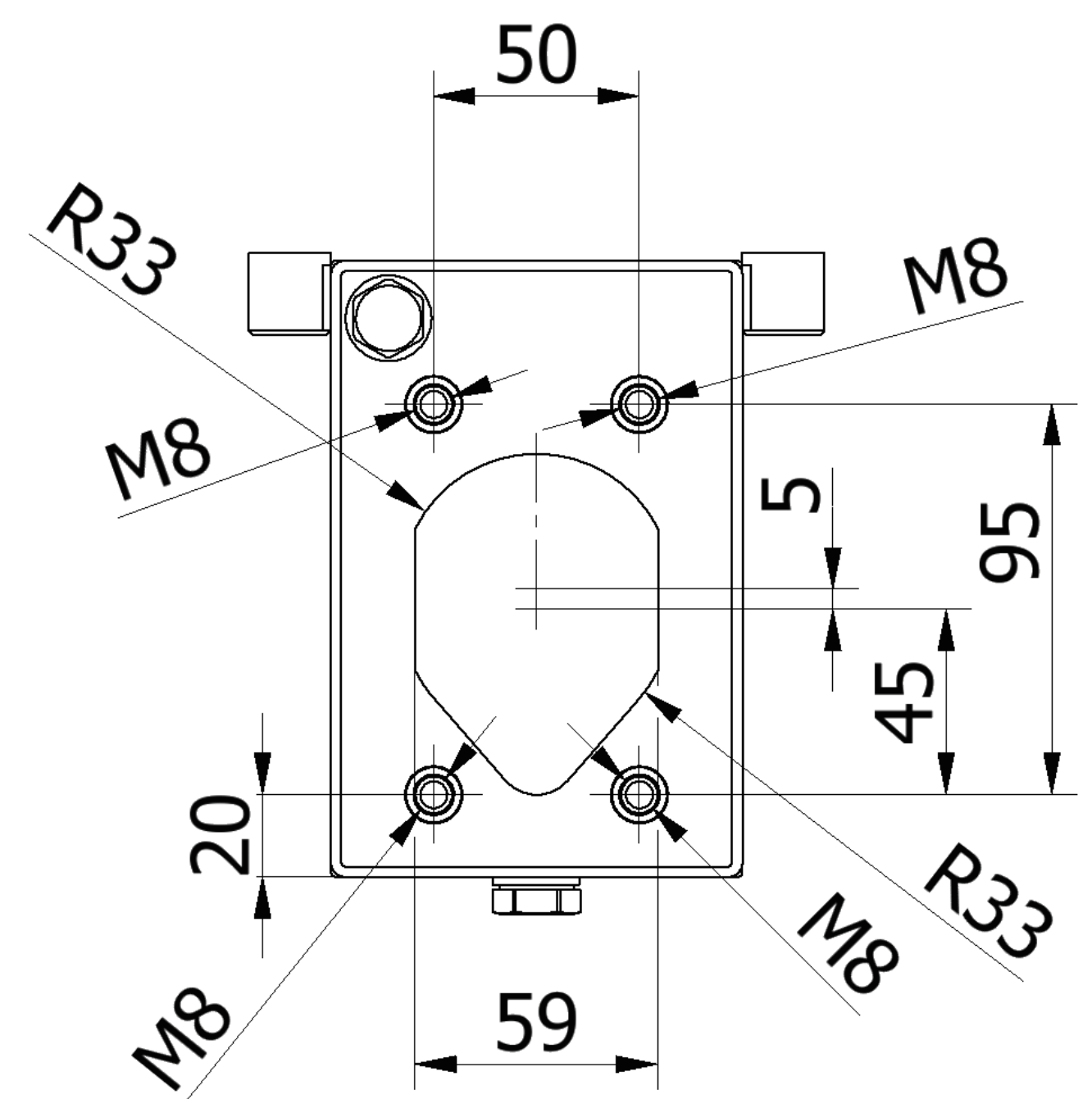
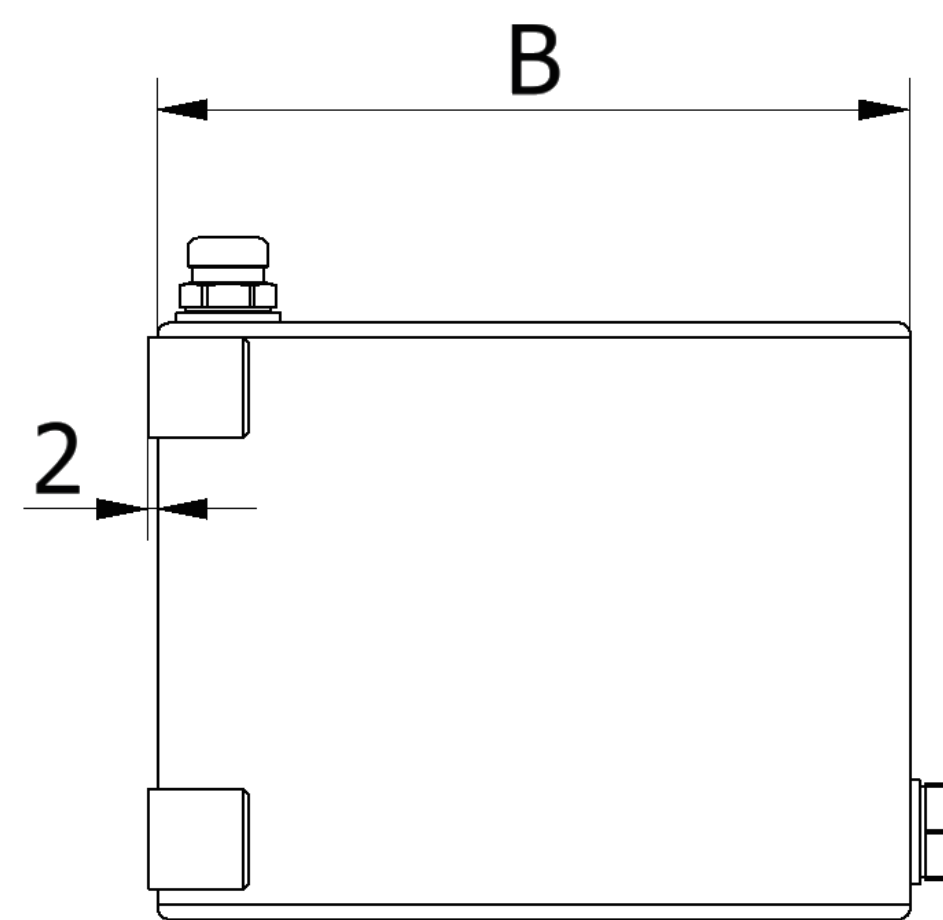
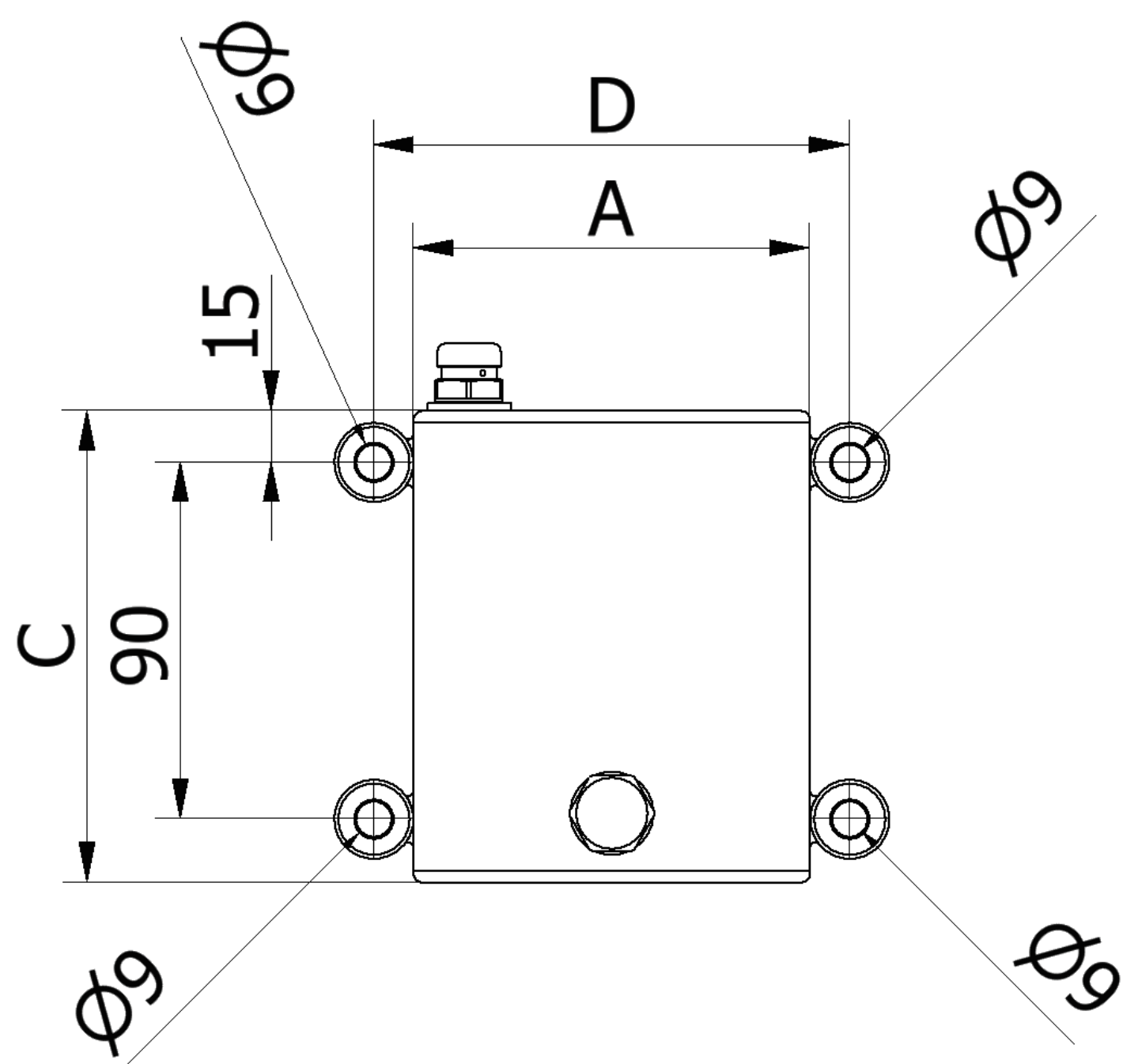

CAPACITY liters	A mm	B mm	C mm	D mm	MASS KG	SUCTION PIPE	CODE
3	100	150	255	120	3,700	Ø10x180 mm	6500.0142